

Bryan "Flexible Water Tube" RV Series Steam & Water Boilers

3,500,000 to 8,000,000 BTUH
Forced draft gas, oil or dual fuel fired



Water Boiler
RV800-W-FDGO



Steam Boiler
RV350-S150-FDG

BRYAN BOILERS

Originators of the "Flexible Water Tube" design





Low initial cost, reliable operating efficiency deliver substantial return on investment

- True “flexible water tube” design guaranteed shock free
- High quality steam for heat or process
- Full five sq ft of heating surface per BHP

Quality construction features:

A. Water side or steam side interior accessible for cleanout and inspection, front and rear openings, upper and lower drums.

B. Large volume water leg downcomers promote rapid internal circulation, temperature equalization and efficient heat transfer.

C. Boiler tube and furnace area access panels: heavy gauge steel casing with 2" high-temperature ceramic fiber insulation, bolted and tightly sealed to boiler frame.

D. Flame observation port in access door at rear of boiler.

E. Single side access; combustion chamber, tubes and burner head are completely accessible from one side simplifying maintenance and minimizing floor space.

F. Minimum sized flue vent.

G. Control panel: all controls installed with connections to terminal strip.

H. Forced draft, flame retention head type burner. Efficient combustion of oil or gas, plus quiet operation.

I. Heavy steel boiler frame, built and stamped in accordance with the appropriate ASME Boiler Code.

J. Heavy gauge steel boiler jacket with rust-resistant zinc coating and enamel finish, insulated with 1½" fiberglass to ensure exceptionally cool outer surface.

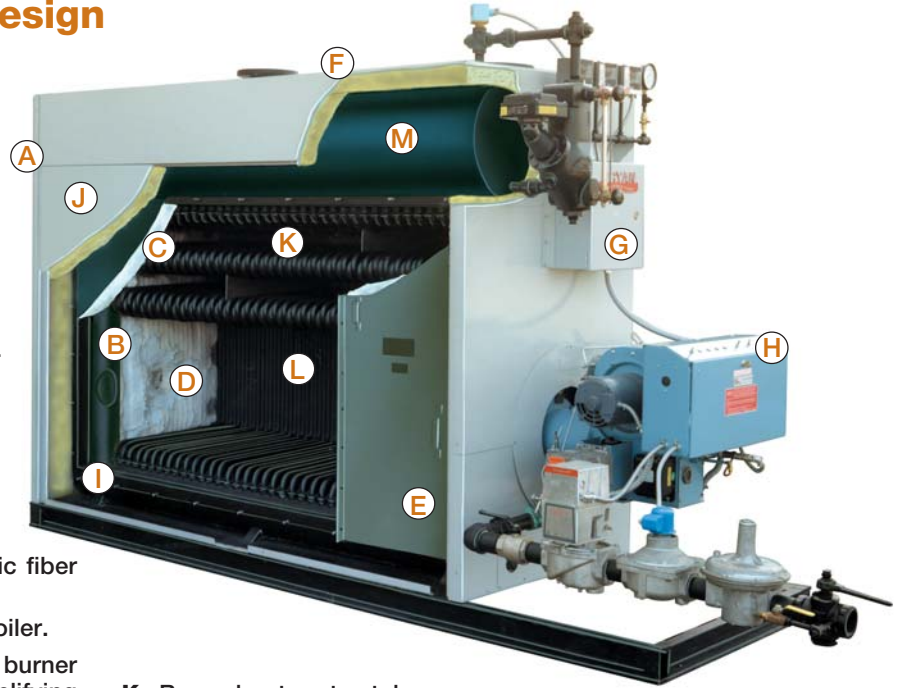

K. Bryan bent water tubes are flexible, individually replaceable without welding or rolling. Never more than two tube configurations.

L. Pressurized design firebox with internal water-cooled furnace with low heat release rate.

M. Steam boilers with extra large drum with high steam release area ensure stable water level and dry steam.

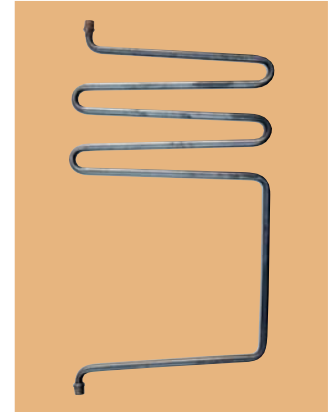

Bryan RV Series Boiler Specifications

BOILER MODEL ⁽¹⁾	INPUT MBH (KW)	OUTPUT @ 80% EFFICIENCY ⁽²⁾		OUTPUT @ 84% EFFICIENCY ⁽³⁾		STEAM OUTPUT ⁽⁴⁾ LBS/HR (KG/HR)	HTG. SURFACE SQ. FT. (M ²)	APPROX. SHIP LBS. (KG)
		MBH (KW)	HP (KW)	MBH (KW)	HP (KW)			
RV350-W	3,500 (1,026)	2,800 (820)	84 (820)	2,940 (861)	88 (861)	—	419 (38.9)	7,000 (3,175)
RV350-S	3,500 (1,026)	2,800 (820)	84 (820)	—	—	2,887 (1,309)	419 (38.9)	7,110 (3,225)
RV400-W	4,000 (1,172)	3,200 (937)	96 (937)	3,360 (984)	100 (984)	—	490 (45.5)	7,690 (3,488)
RV400-S	4,000 (1,172)	3,200 (937)	96 (937)	—	—	3,299 (1,496)	490 (45.5)	8,170 (3,705)
RV450-W	4,500 (1,319)	3,600 (1,054)	108 (1,054)	3,780 (1,107)	113 (1,107)	—	544 (50.6)	8,320 (3,774)
RV450-S	4,500 (1,319)	3,600 (1,054)	108 (1,054)	—	—	3,711 (1,684)	544 (50.6)	8,540 (3,873)
RV500-W	5,000 (1,465)	4,000 (1,172)	120 (1,172)	4,200 (1,230)	125 (1,230)	—	597 (55.5)	9,080 (4,118)
RV500-S	5,000 (1,465)	4,000 (1,172)	120 (1,172)	—	—	4,124 (1,871)	597 (55.5)	9,650 (4,377)
RV550-W	5,500 (1,612)	4,400 (1,289)	131 (1,289)	4,620 (1,353)	138 (1,353)	—	668 (63.9)	9,820 (4,454)
RV550-S	5,500 (1,612)	4,400 (1,289)	131 (1,289)	—	—	4,536 (2,058)	668 (63.9)	10,175 (4,615)
RV600-W	6,000 (1,758)	4,800 (1,406)	143 (1,406)	5,040 (1,476)	151 (1,476)	—	722 (67.1)	10,530 (4,776)
RV600-S	6,000 (1,758)	4,800 (1,406)	143 (1,406)	—	—	4,948 (2,245)	722 (67.1)	11,335 (5,141)
RV700-W	7,000 (2,051)	5,600 (1,640)	167 (1,640)	5,880 (1,722)	176 (1,722)	—	847 (78.7)	11,960 (5,425)
RV700-S	7,000 (2,051)	5,600 (1,640)	167 (1,640)	—	—	5,773 (2,619)	847 (78.7)	12,900 (5,851)
RV800-W	8,000 (2,344)	6,400 (1,875)	191 (1,875)	6,720 (1,968)	201 (1,968)	—	972 (90.3)	13,450 (6,100)
RV800-S	8,000 (2,344)	6,400 (1,875)	191 (1,875)	—	—	6,598 (2,993)	972 (90.3)	14,455 (6,556)

NOTES: (1) W = Water / S = Steam
 (2) Output and horsepower based on boiler industry standard of 80% input.
 (3) Output and horsepower based on an average natural gas combustion efficiency of 84% for hot water boiler. Actual combustion efficiencies for oil will be higher.
 (4) Lbs. steam per hour from and at 212°F.

Guaranteed efficiency and easy maintenance assure low cost operation

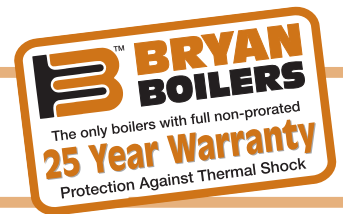

All Bryan RV Series boilers offer these operating and performance features

Guaranteed efficiency

The breakthrough in water tube boiler design that produced the RV Series provides operating efficiency so reliable, we guarantee it to be 84% for hot water boilers and 82% - 15 psi / 80% - 150 psi or better for steam boilers.

The Bryan Flexible Tube

Bryan's exclusive "Flexible Tube" design eliminates the possibility of damage from so-called "thermal shock." Tubes are easily removable and replaceable, without welding or rolling, eliminating long, expensive downtime should repairs ever be required.

Water cooled furnace

The configuration of the water tubes provides a water cooled combustion chamber. A high percentage of

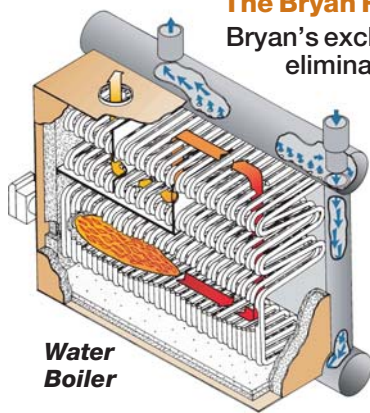

Water Boiler

the heating surface is exposed to direct radiant heat, increasing water velocities and heat transfer.

Large steam drum

The steam drum has generous water volume and steam release area. This design, along with effective drum internal functions, results in a stable water level and produces extremely dry steam at all load conditions.

Accessibility of furnace and tube area

Inner panel provides easy and complete access to furnace and boiler tube area, as well as to burner head. All panels are heavily insulated and sealed to boiler frame. All access is from only one side.

Compact design, minimum floor space

With our compact water tube design, the overall size of the unit is less than most other types of boilers, yet maintains a full five square feet of heating surface area per HP.

Needing only 32" for tube removal, and on only one side of the boiler, the RV Series boiler occupies very little space in the boiler room. This can result in considerable savings in building costs. Pressurized firing permits minimum sized breaching and vent.

Multi-pass flue gas travel

High velocity four-pass flue gas travel is obtained by a unique baffling system. This contributes to maximum fire side heat transfer and overall high boiler efficiencies.

Thermal blend water return

Bryan's unique "thermal blend" return blends cold or cooler return water with warmer boiler water abridging it to design operating temperatures. An injector tube directs the "mixed" water flow through the downcomer to the lower header and heating surfaces at a temperature above possible condensing conditions. This reduces the possibility of "cold spots" and damage from corrosive condensation.

Positive internal circulation

Each pass of the Bryan water tube slopes upward. This configuration, along with the large volume down-comer water legs, provides the extremely rapid natural thermal internal circulation, promoting both high efficiency of heat transfer and uniform temperature throughout the boiler. Eliminating stress damage caused by unequal temperature distribution is especially important for heating systems, particularly where intermittent or continuous low temperature water returns may be encountered.

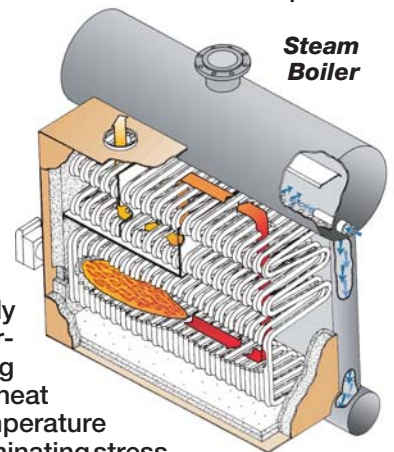

Steam Boiler

Bryan RV Series Boilers Standard and Optional Equipment

STANDARD EQUIPMENT FURNISHED

Water Boiler

Combination thermometer and altitude gauge, ASME Code rated boiler relief valve, water temperature control (240°F max std.), high limit control, probe LWCO.

Steam Boiler

Steam pressure gauge, steam pressure control, combination low water cutoff and pump control, auxiliary low water cutoff, high limit pressure control, ASME-rated safety valve, water glass set.

Straight gas fired unit

Electronic combustion safety control, automatic operating gas valve, safety gas valve, pilot solenoid valve, pilot ignition assembly, main manual gas shut-off valve, pilot cock, pilot and main gas pressure regulators, air safety

switch, control panel, all controls installed and wired.

Straight oil fired unit

Electronic combustion safety control, dual oil valves oil ignition transformer, two-stage fuel unit, gas pilot, oil nozzle assembly, control panel, all controls installed and wired.

Combination gas-oil unit

Electronic combustion safety control, automatic operating gas valve, safety gas valve, pilot solenoid valve, pilot ignition assembly, main manual gas shut-off valve, pilot cock, pilot and main gas pressure regulators, air safety switch, manual fuel selector switch, dual oil valves, oil ignition transformer, two-stage fuel unit, oil ignition and nozzle assembly, control panel, all controls installed and wired.

OPTIONAL EQUIPMENT, EXTRA COST

1. Manual reset high limit control
2. Manual reset low water cutoff
3. Auxiliary low water cutoff
4. Combination low water cutoff and feeder
5. Alarm bells or horns
6. UL, CUL, CSD-1, FM, IRI or other insurance approved control systems
7. Indicating lights, as desired
8. Lead-lag systems for two or more boilers with or without outdoor reset control
9. Draft control system
10. Low NOx package

OPTIONAL CONSTRUCTION: Steam boiler

Optional construction to ASME Power Boiler Code requirements for pressure exceeding 150 psi to maximum of 300 psi design pressure.

Hot water boiler

Optional construction to ASME Power Boiler Code requirements for temperatures exceeding 240° F and/or pressure exceeding 160 psi to maximum of 285° F operating and 300° F design temperature and 250 psi.

When ordering, please specify:

1. Boiler size
2. Supply and return temperatures required
3. Boiler relief valve setting
4. Type of fuel: natural, LP, or other gas and/or No. 2 oil
5. If gas, type, BTU content, specific gravity and pressure available
6. Electric power voltage, phase and frequency
7. Optional extra equipment or construction
8. Special approvals required (UL, CUL, CSD-1, FM, or IRI)
9. Altitude

Bryan RV Series Steam & Hot Water Boilers

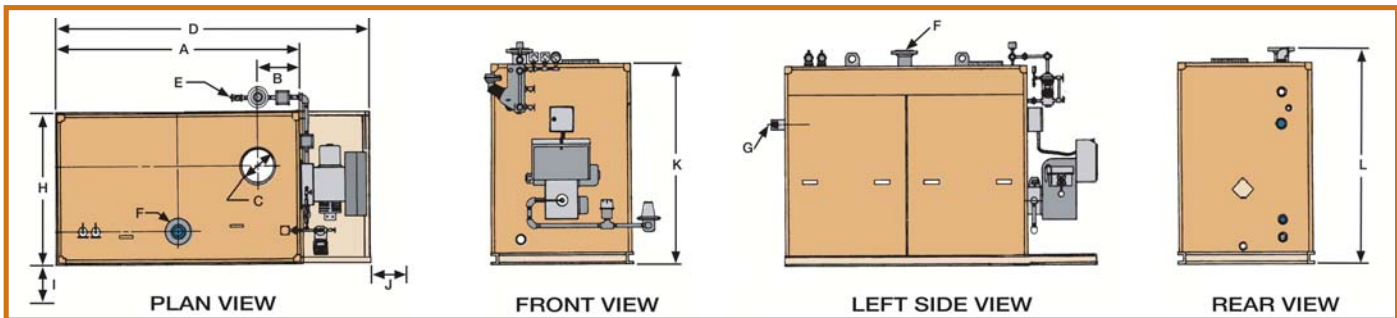

STEAM HEATING/PROCESSING BOILER DIMENSIONS in inches (cm)

Boiler Model Number	A	B	C	D	E	F		G	H	I	J	K	L
	Length of Jacket	Flue Location	Flue Size	Overall Length	Gas Train Connection	15 psi	150 psi	Return Conn.	Width Outside Jacket	Min. Tube Removal Clearance	Clearance for Servicing Burner	Height Over Jacket	Floor to Flow Nozzle
RV350-S	98 (248.92)	16 (40.64)	16 (40.64)	130½ (331.47)	2½ (6.35)	6 (15.24)	4 (10.16)	2 (5.08)	55 (139.70)	32 (81.28)	48 (121.92)	100¼ (254.64)	104¾ (266.1)
RV400-S	111 (281.94)	18¾ (47.63)	16 (40.64)	143½ (364.49)	2½ (6.35)	8 (20.32)	6 (15.24)	2 (5.08)	55 (139.70)	32 (81.28)	48 (121.92)	100¼ (254.64)	104¾ (266.1)
RV450-S	120½ (306.07)	18¾ (47.63)	16 (40.64)	153¾ (389.26)	2½ (6.35)	8 (20.32)	6 (15.24)	2 (5.08)	55 (139.70)	32 (81.28)	48 (121.92)	100¼ (254.64)	104¾ (266.1)
RV500-S	130¼ (330.84)	18¾ (47.63)	16 (40.64)	163 (414.02)	2½ (6.35)	8 (20.32)	6 (15.24)	2 (5.08)	55 (139.70)	32 (81.28)	48 (121.92)	100¼ (254.64)	104¾ (266.1)
RV550-S	143¼ (363.83)	18¾ (47.63)	16 (40.64)	175¾ (446.41)	2½ (6.35)	10 (25.40)	6 (15.24)	2 (5.08)	55 (139.70)	32 (81.28)	48 (121.92)	100¼ (254.64)	104¾ (266.1)
RV600-S	152¾ (387.99)	18¾ (47.63)	16 (40.64)	185¾ (470.54)	2½ (6.35)	10 (25.40)	6 (15.24)	2 (5.08)	55 (139.70)	32 (81.28)	48 (121.92)	100¼ (254.64)	104¾ (266.1)
RV700-S	175¾ (445.14)	20¾ (52.71)	20 (50.80)	214½ (544.83)	2½ (6.35)	10 (25.40)	6 (15.24)	2 (5.08)	55 (139.70)	32 (81.28)	48 (121.92)	100¼ (254.64)	104¾ (266.1)
RV800-S	197¾ (502.29)	20¾ (52.71)	20 (50.80)	237¾ (602.62)	2½ (6.35)	10 (25.40)	6 (15.24)	2 (5.08)	55 (139.70)	32 (81.28)	48 (121.92)	100¼ (254.64)	104¾ (266.1)

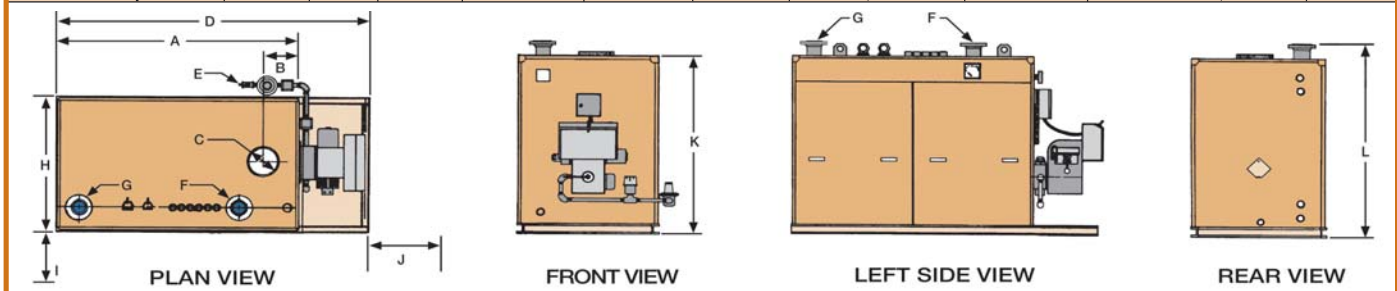

HOT WATER HEATING BOILER DIMENSIONS in inches (cm)

Boiler Model Number	A	B	C	D	E	F	G	H	I	J	K	L
	Length of Jacket	Flue Location	Flue Size	Overall Length	Gas Train Connection	Supply Nozzle	Return Nozzle	Width Outside Jacket	Min. Tube Removal Clearance	Clearance for Servicing Burner	Height Over Jacket	Floor to Flow Nozzle
RV350-W	98 (248.92)	16 (40.64)	16 (40.64)	130½ (331.47)	2½ (6.35)	4 (10.16)	4 (10.16)	50 (127.00)	32 (81.28)	48 (121.92)	87½ (222.25)	90 (228.60)
RV400-W	111 (281.94)	18¾ (47.63)	16 (40.64)	143½ (364.49)	2½ (6.35)	6 (15.24)	6 (15.24)	50 (127.00)	32 (81.28)	48 (121.92)	87½ (222.25)	90 (228.60)
RV450-W	120½ (306.07)	18¾ (47.63)	16 (40.64)	153¾ (389.25)	2½ (6.35)	6 (15.24)	6 (15.24)	50 (127.00)	32 (81.28)	48 (121.92)	87½ (222.25)	90 (228.60)
RV500-W	130¼ (330.84)	18¾ (47.63)	16 (40.64)	163 (414.02)	2½ (6.35)	6 (15.24)	6 (15.24)	50 (127.00)	32 (81.28)	48 (121.92)	87½ (222.25)	90 (228.60)
RV550-W	143¼ (364.49)	18¾ (47.63)	16 (40.64)	175¾ (446.41)	2½ (6.35)	6 (15.24)	6 (15.24)	50 (127.00)	32 (81.28)	48 (121.92)	87½ (222.25)	90 (228.60)
RV600-W	152¾ (387.99)	18¾ (47.63)	16 (40.64)	185¾ (470.54)	2½ (6.35)	6 (15.24)	6 (15.24)	50 (127.00)	32 (81.28)	48 (121.92)	87½ (222.25)	90 (228.60)
RV700-W	175¾ (446.41)	20¾ (52.71)	20 (50.80)	214½ (544.83)	2½ (6.35)	6 (15.24)	6 (15.24)	50 (127.00)	32 (81.28)	48 (121.92)	87½ (222.25)	90 (228.60)
RV800-W	197¾ (502.29)	20¾ (52.71)	20 (50.80)	237¾ (602.62)	2½ (6.35)	6 (15.24)	6 (15.24)	50 (127.00)	32 (81.28)	48 (121.92)	87½ (222.25)	90 (228.60)

Specifications subject to change without notice. Consult factory to consult on other boiler options.



Bryan Steam LLC — Since 1916

783 N. Chili Ave., Peru, Indiana 46970 U.S.A.

Phone: 765-473-6651 • Internet: www.bryanboilers.com

Fax: 765-473-3074 • E-mail: bryanboilers@iquest.net